

MQ8260C×1600/1800

crankshaft grinding machine

The crankshaft grinder model MQ8260C is modified on the basis of the Model MQ8260A and intended for use in the automobiles, tractors diesel engine works and their repair shops to grind the journals and crankpins of crankshaft.

- Three different work speeds are obtainable by making use of the belts in the work head. The cover can be opened so that the belts can be changed conveniently.
- Cross swallow-tailed chucks are selectively used in the headstock and tailstock.
- Friction coupling is used in the headstock transmission chain for its easy adjustment.
- Single layer table, with an oblique angle of 10 degree, longitudinal traverse can be operated either by hand or by power.
- Wheel head rapid approach and withdrawal effected by hydraulic means can be digitally displayed at a resolution of 0.005mm.
- The wheel spindle being of 80mm in diameter has good rigidity and strength
- The roller ways are for wheel head movement
- The bed ways and wheel head ways are lubricated in an automatic cycle by means of the oil pump.
- Plastic coat is adhered to the bed way.
- Air cushion can be used on the tailstock providing easy adjustment. Crosswise movement of tailstock is effected.

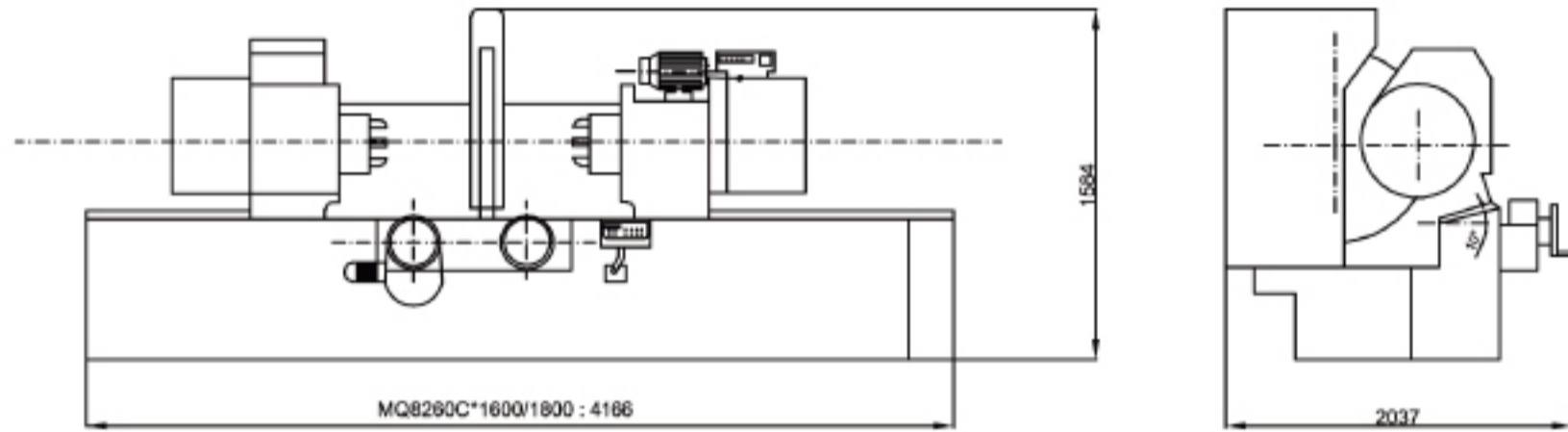

Technical Specifications

Model	Unit	MQ8260C×1600	MQ8260C×1800
Max. work diameter × Max. work length	mm	Φ600×1600	Φ600×1800
Capacity	Max. swing over table	mm	Φ600
	Work diameter ground with steady rest	mm	Φ30~100
	Throw of crankshaft	mm	Φ110
	Max. work length ground in 3 jaw chuck	mm	1400
	Max. work length ground between centers	mm	1600
Headstock	Max. work weight	kg	120
	Centre height	mm	300
Wheelhead	Work speed	rpm	25,45,95
	Max. cross movement	mm	185
	Wheelhead rapid approach & withdrawal	mm	100
	Wheelhead feed per turn of cross feed handwheel	mm	1
Grinding wheel	Wheelhead feed per grad of cross feed handwheel	mm	0.005
	Wheel spindle speed	rpm	740, 890
	Wheel peripheral speed	m/sec	25.6~35
Table	Wheel size	mm	Φ900×32×Φ305
	Table traverse per turn of handwheel coarse	mm	5.88
Overall capacity of motor	Table traverse per turn of handwheel fine	mm	1.68
	Overall dimensions (L×W×H)	mm	4166×2037×1584
Working accuracy	Package dimensions (L×W×H)	mm	4300×2200×2000
	Weight	kg	6000
Overall capacity of motor	Ovality(new standard)	mm	0.005
	Cylindricity	mm	0.01
	Roughness	μm	Ra 0.32

Standard Accessories

- jaw chuck
- wheel dresser
- wheel balancing arbor
- leveling wedge
- wheel adapto
- driving dog
- vertical aligning stand
- horizontal aligning stand
- wheel balancing stand
- hanging measuring deive
- steady rest
- centering deive
- grinding wheel

Optional Accessories

- end dresser
- digital readout
- polisher
- diamond dresser

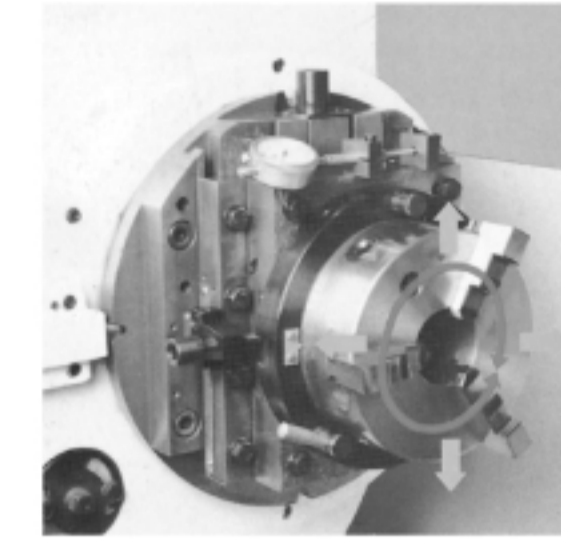

Cross swallow-tailed jaw chuck

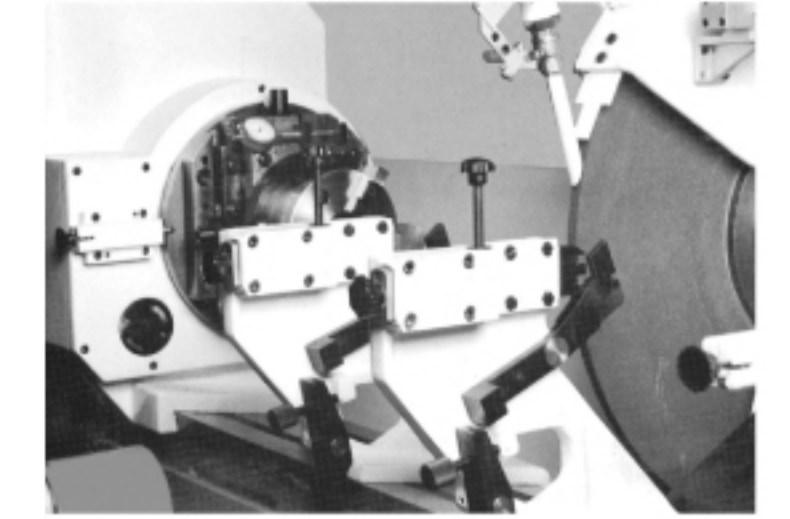

Steady rest

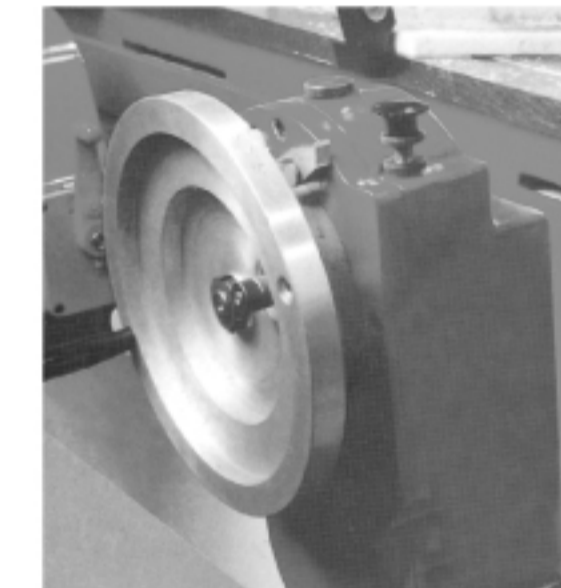

Push button for fine feed

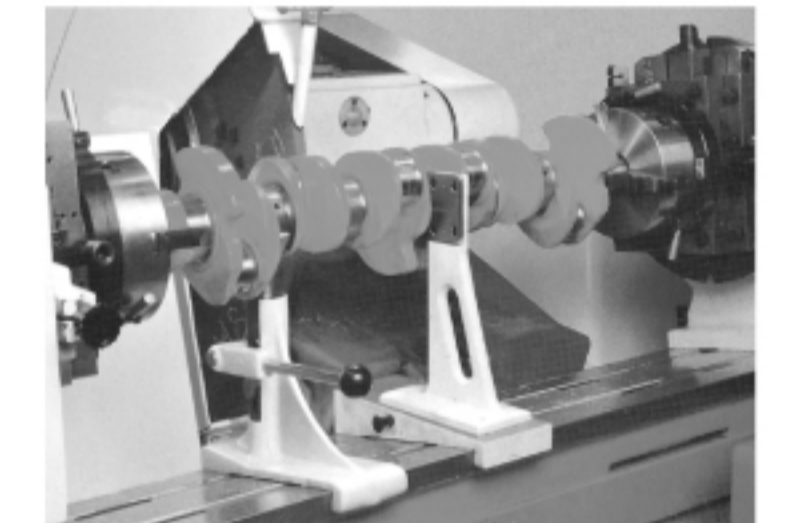

Vertical & horizontal aligning stand

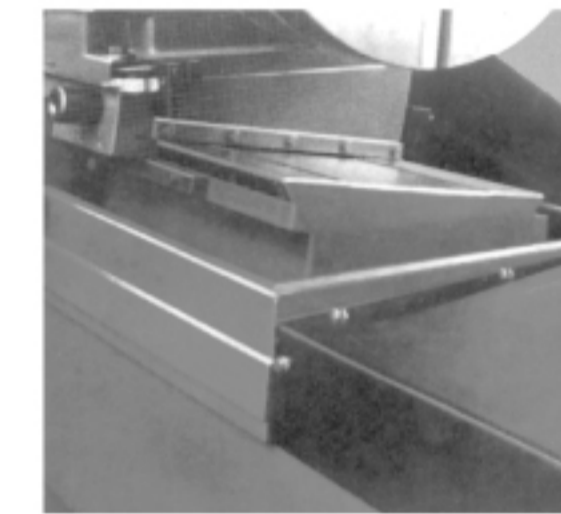

Oblique angle table(10°)

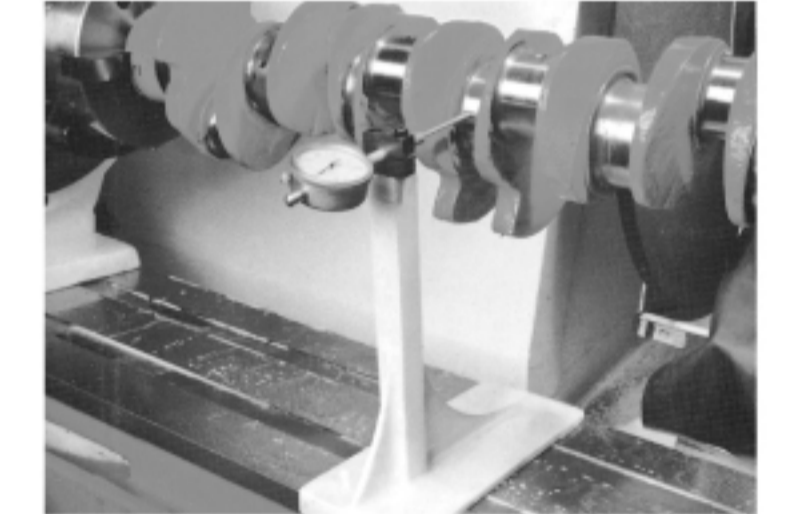

Centering device



Head stock speed quickly change belt

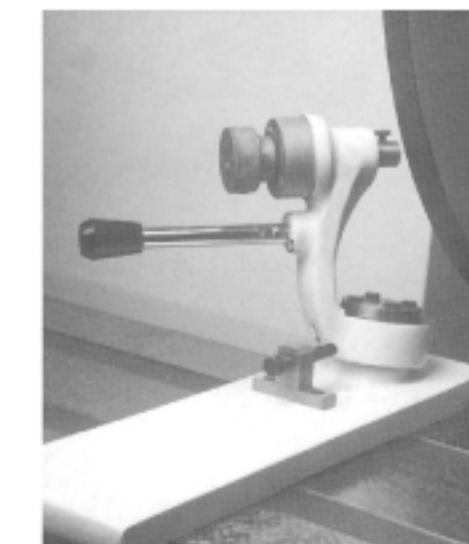

Wheel dresser

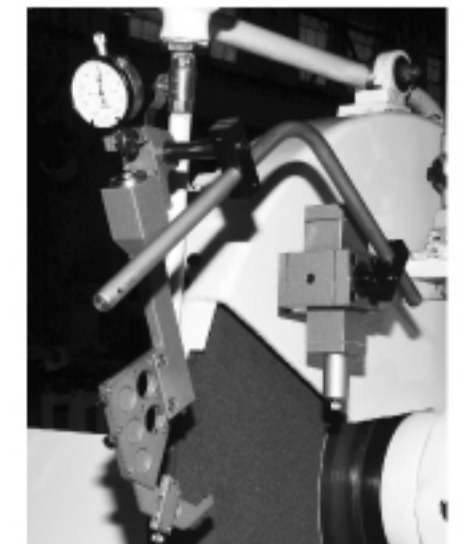

Hanging measuring device

Accessories

crankshaft grinding machine MQ8260C×1600/1800

Crankshaft grinding machine



vertical stand

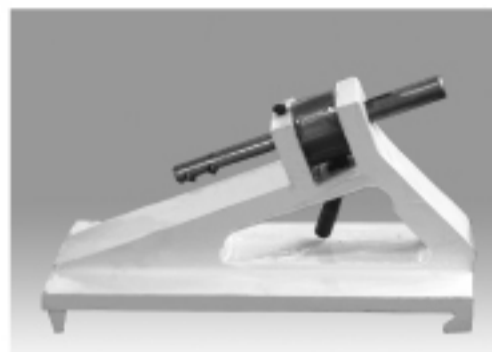

end dresser

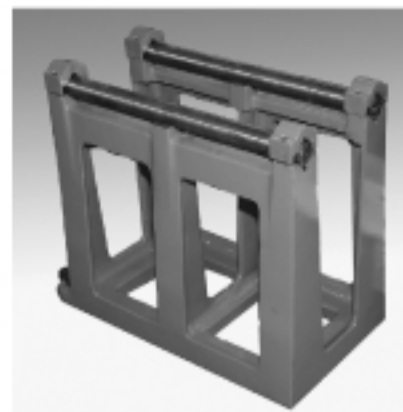

wheel balancing stand



wheel dresser



centering device



horizontal stand



diamond dresser



steady rest



digital readout

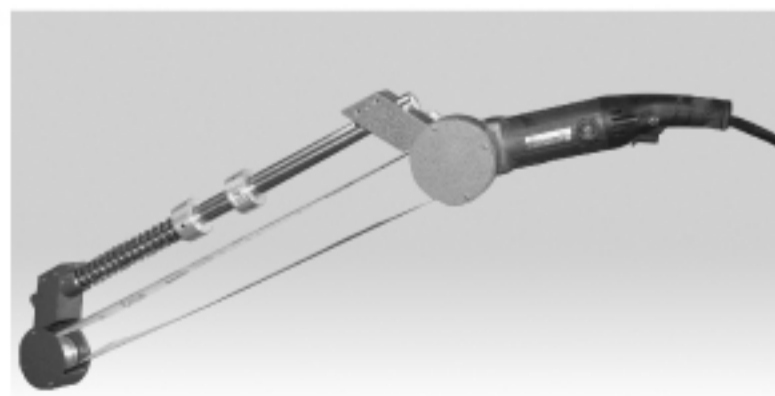

polisher

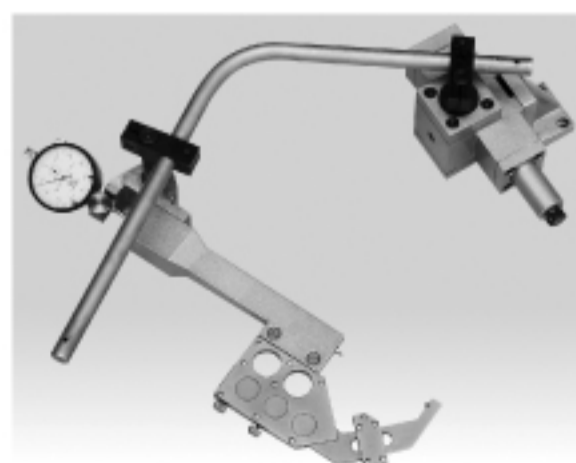

hanging measuring device